

HM04-M2 SERIES

Application

Downlight is designed to use for office buildings, shopping centers, convenience stores, modern trade stores, discount stores, hotels, restaurants, residences, recreation centers, museums, etc.

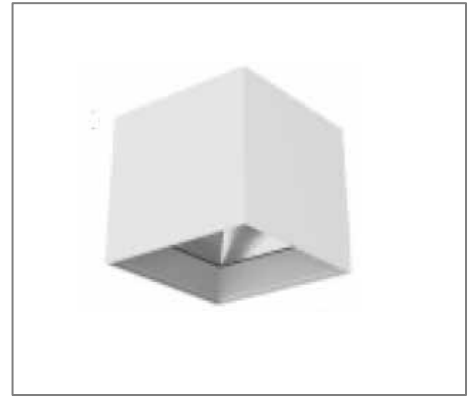

Specification

Input Voltage	220-240 V AC /100-240 V AC
Frequency	50/60Hz
Lumen	85-105 lm/W
CRI	> 80/90
Color Finish	White / Black
Dim Option	Optional
IP Rating	IP 20

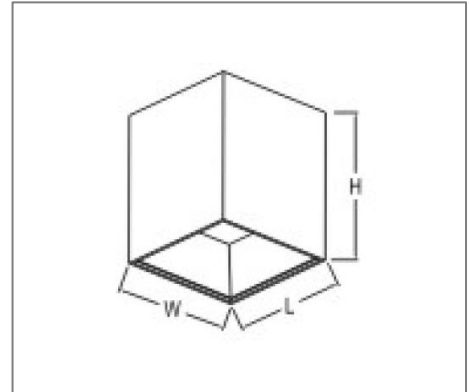

Ordering Data

Part No.	Power	Beam Angle	Dimension (mm)	CCT
EVO-HM04-M2-R-7W-27	7W	38°	80 (L) X 80 (W) X 104(H)	2700K
EVO-HM04-M2-R-7W-30	7W	38°	80 (L) X 80 (W) X 104(H)	3000K
EVO-HM04-M2-R-7W-40	7W	38°	80 (L) X 80 (W) X 104(H)	4000K
EVO-HM04-M2-R-7W-50	7W	38°	80 (L) X 80 (W) X 104(H)	5000K
EVO-HM04-M2-R-10W-27	10W	38°	80 (L) X 80 (W) X 104(H)	2700K
EVO-HM04-M2-R-10W-30	10W	38°	80 (L) X 80 (W) X 104(H)	3000K
EVO-HM04-M2-R-10W-40	10W	38°	80 (L) X 80 (W) X 104(H)	4000K
EVO-HM04-M2-R-10W-50	10W	38°	80 (L) X 80 (W) X 104(H)	5000K