

HD04-P3-DR SERIES

Application

Recessed downlight is designed to use for office buildings, shopping centers, convenience stores, modern trade stores, discount stores, hotels, restaurants, residences, recreation centers, museums, etc.

Specification

Input Voltage	200-240 V AC /100-240 V AC
Frequency	50/60Hz
Lumen	90-110 lm/W
CRI	> 80/90
Color Finish	White + Black
Dim Option	Optional
IP Rating	IP 20

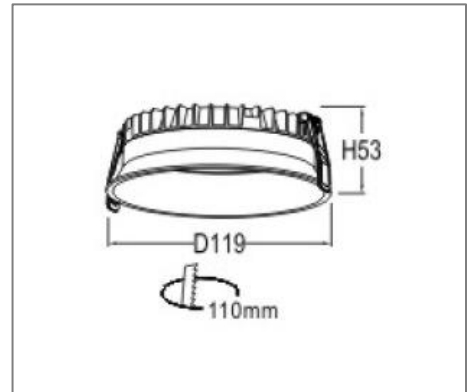

Ordering Data

Part No.	Power	Beam Angle	CCT
EVO-HD04-P3-DR-7W-27	7W	90°	2700K
EVO-HD04-P3-DR-7W-30	7W	90°	3000K
EVO-HD04-P3-DR-7W-40	7W	90°	4000K
EVO-HD04-P3-DR-7W-50	7W	90°	5000K
EVO-HD04-P3-DR-7W-60	7W	90°	6000K
EVO-HD04-P3-DR-10W-27	10W	90°	2700K
EVO-HD04-P3-DR-10W-30	10W	90°	3000K
EVO-HD04-P3-DR-10W-40	10W	90°	4000K
EVO-HD04-P3-DR-10W-50	10W	90°	5000K
EVO-HD04-P3-DR-10W-60	10W	90°	6000K
EVO-HD04-P3-DR-15W-27	15W	90°	2700K
EVO-HD04-P3-DR-15W-30	15W	90°	3000K
EVO-HD04-P3-DR-15W-40	15W	90°	4000K
EVO-HD04-P3-DR-15W-50	15W	90°	5000K
EVO-HD04-P3-DR-15W-60	15W	90°	6000K

Remark: DR= Diffuser Round.