

## HT75-C8-B2030 SERIES

### Application

Track light is designed to use for office buildings, shopping centers, convenience stores, modern trade stores, discount stores, hotels, restaurants, residences, recreation centers, museums, etc.



### Specification

<b>Input Voltage</b>	220-240 V AC /120-240 V AC
<b>Frequency</b>	50/60Hz
<b>Lumen</b>	90-100 lm/W
<b>CRI</b>	> 80/90
<b>Color Finish</b>	White / Black
<b>Dim Option</b>	Optional
<b>IP Rating</b>	IP 20
<b>Track</b>	1/2/3 Phase

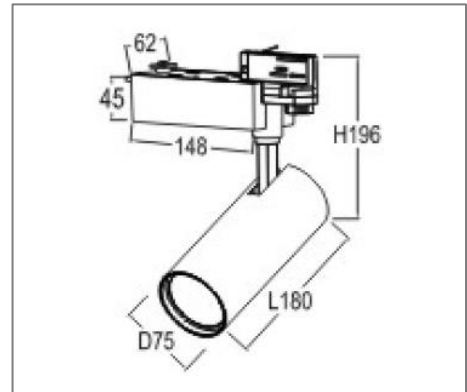

### Ordering Data

Part No.	Power	Beam Angle	CCT
EVO-HT75-C8-B-20W-27	20W	15°/24°/36°	2700K
EVO-HT75-C8-B-20W-30	20W	15°/24°/36°	3000K
EVO-HT75-C8-B-20W-40	20W	15°/24°/36°	4000K
EVO-HT75-C8-B-20W-50	20W	15°/24°/36°	5000K
EVO-HT75-C8-B-30W-27	30W	15°/24°/36°	2700K
EVO-HT75-C8-B-30W-30	30W	15°/24°/36°	3000K
EVO-HT75-C8-B-30W-40	30W	15°/24°/36°	4000K
EVO-HT75-C8-B-30W-50	30W	15°/24°/36°	5000K

Remark: B= Driver in box..