

## E-LS7575 SERIES

### Application

Suspended/Surface Linear Light is designed to use for office buildings, shopping centers, convenience stores, modern trade stores, discount stores, hotels, restaurants, residences, recreation centers, museums, etc.

### Specification

<b>Input Voltage</b>	200-240 V AC
<b>IP Rating</b>	IP20
<b>Rendering Index</b>	> 90
<b>Lumen Per Watt</b>	130lm/w
<b>LED Operating Life</b>	>50, 000 Hrs
<b>Colour Correlated Temperature</b>	3000K, 4000K, 6500K
<b>Available Colour</b>	White/Black/Grey
<b>Beam Angle</b>	120°
<b>Dimmable</b>	Optional
<b>Mounting Method</b>	Suspended, Surface Mounted

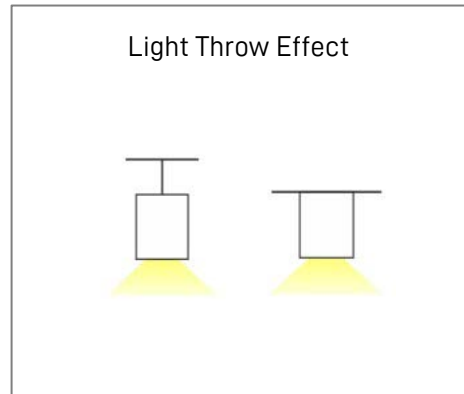
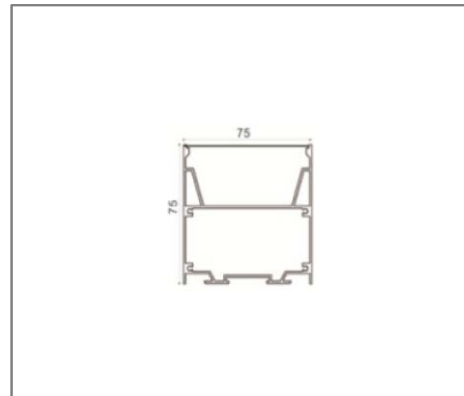
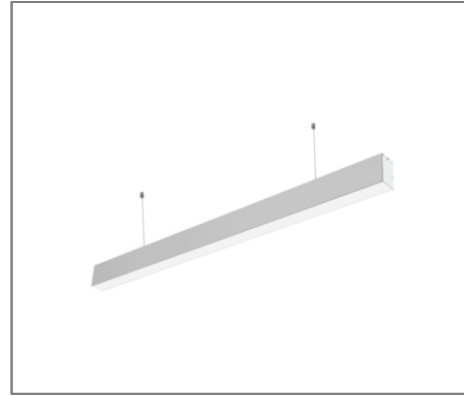

### Ordering Data

Part No.	Power	Length (L x W x H)
EVO-E-LS7575-18W	18W	606mm x 75mm x 75mm
EVO-E-LS7575-36W	36W	1206mm x 75mm x 75mm
EVO-E-LS7575-54W	54W	1806mm x 75mm x 75mm
EVO-E-LS7575-72W	72W	2406mm x 75mm x 75mm