

E-LS5035 SERIES

Application

Suspended/Surface Linear Light is designed to use for office buildings, shopping centers, convenience stores, modern trade stores, discount stores, hotels, restaurants, residences, recreation centers, museums, etc.

Specification

Input Voltage	200-240 V AC
IP Rating	IP20
Rendering Index	> 90
Lumen Per Watt	130lm/w
LED Operating Life	>50, 000 Hrs
Colour Correlated Temperature	3000K, 4000K, 6500K
Available Colour	White/Black/Grey
Beam Angle	120°
Dimmable	Optional
Mounting Method	Suspended, Surface Mounted

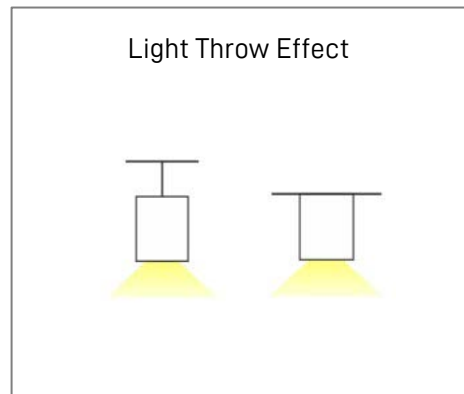
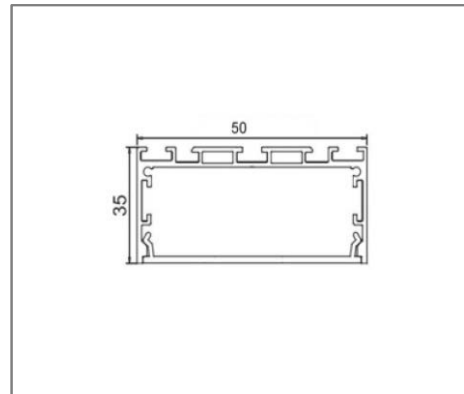

Ordering Data

Part No.	Power	Length (L x W x H)
EVO-E-LS5035-36W	36W	1206mm x 50mm x 35mm
EVO-E-LS5035-54W	54W	1806mm x 50mm x 35mm
EVO-E-LS5035-72W	72W	2406mm x 50mm x 35mm