

HM05-M2 SERIES

Application

Downlight is designed to use for office buildings, shopping centers, convenience stores, modern trade stores, discount stores, hotels, restaurants, residences, recreation centers, museums, etc.



Specification

Input Voltage	220-240 V AC /100-240 V AC
Frequency	50/60Hz
Lumen	85-105 lm/W
CRI	> 80/90
Color Finish	White / Black
Dim Option	Optional
IP Rating	IP 20

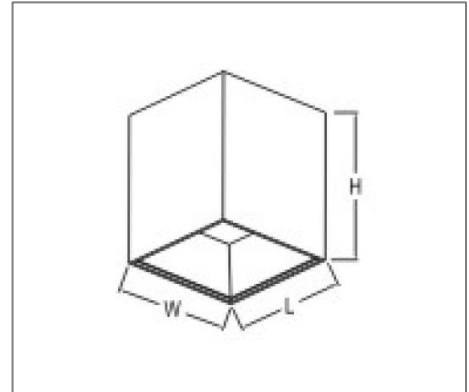

Ordering Data

Part No.	Power	Beam Angle	Dimension (mm)	CCT
EVO-HM05-M2-R-10W-27	10W	38°	101 (L) X 101 (W) X 119(H)	2700K
EVO-HM05-M2-R-10W-30	10W	38°	101 (L) X 101 (W) X 119(H)	3000K
EVO-HM05-M2-R-10W-40	10W	38°	101 (L) X 101 (W) X 119(H)	4000K
EVO-HM05-M2-R-10W-50	10W	38°	101 (L) X 101 (W) X 119(H)	5000K
EVO-HM05-M2-R-15W-27	15W	38°	101 (L) X 101 (W) X 119(H)	2700K
EVO-HM05-M2-R-15W-30	15W	38°	101 (L) X 101 (W) X 119(H)	3000K
EVO-HM05-M2-R-15W-40	15W	38°	101 (L) X 101 (W) X 119(H)	4000K
EVO-HM05-M2-R-15W-50	15W	38°	101 (L) X 101 (W) X 119(H)	5000K