

## HD03-V1-D SERIES

### Application

Recessed downlight is designed to use for office buildings, shopping centers, convenience stores, modern trade stores, discount stores, hotels, restaurants, residences, recreation centers, museums, etc.



### Specification

<b>Input Voltage</b>	200-240 V AC /100-240 V AC
<b>Frequency</b>	50/60Hz
<b>Lumen</b>	85-105 lm/W
<b>CRI</b>	> 80/90
<b>Color Finish</b>	White + Iron Grey
<b>Dim Option</b>	Optional
<b>IP Rating</b>	IP 20

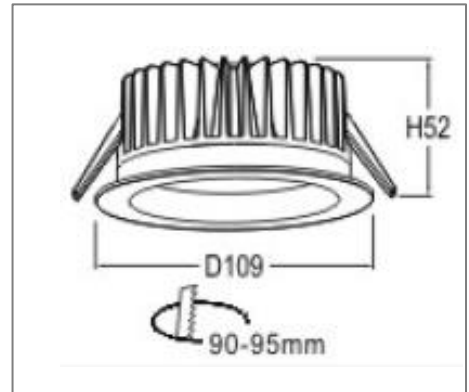

### Ordering Data

Part No.	Power	Beam Angle	CCT
EVO-HD03-V1-D-7W-27	7W	90°	2700K
EVO-HD03-V1-D-7W-30	7W	90°	3000K
EVO-HD03-V1-D-7W-40	7W	90°	4000K
EVO-HD03-V1-D-7W-50	7W	90°	5000K
EVO-HD03-V1-D-7W-60	7W	90°	6000K
EVO-HD03-V1-D-10W-27	10W	90°	2700K
EVO-HD03-V1-D-10W-30	10W	90°	3000K
EVO-HD03-V1-D-10W-40	10W	90°	4000K
EVO-HD03-V1-D-10W-50	10W	90°	5000K
EVO-HD03-V1-D-10W-60	10W	90°	6000K
EVO-HD03-V1-D-15W-27	15W	90°	2700K
EVO-HD03-V1-D-15W-30	15W	90°	3000K
EVO-HD03-V1-D-15W-40	15W	90°	4000K
EVO-HD03-V1-D-15W-50	15W	90°	5000K
EVO-HD03-V1-D-15W-60	15W	90°	6000K

Remark: D= Diffuser, R= Reflector..